

REF PP17P

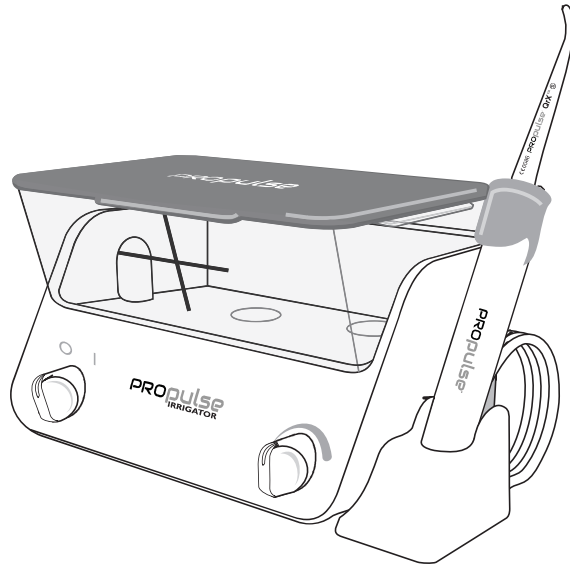

PROPULSE[®] IRRIGATOR



CE
0086

mirage
Health Group

PROPULSE®

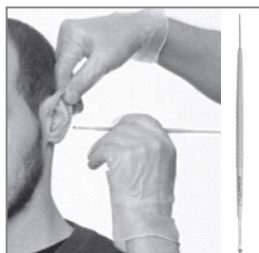

Propulse® ProScoop™
INS0040

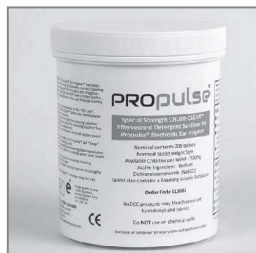

Propulse® Cleaning Tablets
(x200 per pack)
CL0001



Propulse® Head Lamp
INS0036



Propulse® QrX™ Single Use
Tip (x100 per pack)
KIT5002

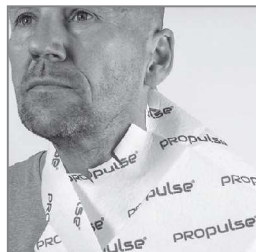

Propulse® ProTect™ Cape
KIT1012



Propulse® Carry Case
KIT1005

INTENDED PURPOSE

The Propulse® Ear Irrigator is intended to:

- a) Facilitate the removal of cerumen and foreign bodies that are not hygroscopic from the meatus.
- b) Remove discharge, keratin or debris from the external auditory meatus by irrigation with warm water.

Reasons for using this procedure are to:

- a) Correctly treat otitis externa where the meatus is obscured by debris.
- b) Improve conduction of sound into the ear, where impacted wax is believed to be the cause of a hearing defect.
- c) Examine the external auditory meatus and the tympanic membrane.
- d) Remove a cause of discomfort.

This procedure should ONLY be carried out by a suitably qualified healthcare professional.

WARNINGS AND CAUTIONS

- This manual must be read and understood before the Propulse® Ear Irrigator is used.
- Only suitably trained staff should use the device. Mirage can advise on the availability of training courses offered by relevant organisations.
- The Propulse® QrX™ Tip is “Single Use” and should be disposed of in accordance with local authority guidelines after use.
- Reuse of the Propulse® QrX™ Tip increases the risk of cross-infection.
- Propulse® Ear Irrigator must not be immersed in water.
- Only clean the device as specified in this manual (See page 10).
- If any changes in performance occur, turn off the Propulse® Ear Irrigator, disconnect from the mains electricity supply and DO NOT use (See page 11).
- The device has no user serviceable parts (See page 13).
- Use recommended Propulse® accessories only.
- Do not use Propulse® accessories with other devices.
- If the device is to be used for domestic visits, it is strongly recommended that a Propulse® Carry Case is used to prevent damage and contamination.
- The Propulse® Ear Irrigator is not user repairable and should be returned to your Propulse® supplier or Mirage Health Group (UK customers only) for service and/or repair. **It is recommended that the Propulse® Ear Irrigator is serviced annually.**

Please note: Damage caused to your Propulse® Ear Irrigator by the use of accessories, consumables or service agents not recommended by Mirage Health Group, will invalidate your warranty.

⚠ DO NOT IRRIGATE the ears if:

- Consent is not given and/or the patient is uncooperative.
- Previous complications occurred following this procedure.
- There is a history of a middle ear infection in the last six weeks.
- The patient has undergone ear surgery (apart from grommets that have extruded at least 18 months previously and the patient has been discharged from the ENT dept.)
- The patient has a perforation or there is a history of a mucous discharge in the last year.
- The patient has a cleft palate (repaired or not).
- In the presence of acute otitis externa; an oedematous ear canal combined with pain and tenderness of the pinna.
- If patient complains of pain - STOP IMMEDIATELY.

**Please refer to Contraindications on page 12.*

COMPONENT / PARTS IDENTIFICATION

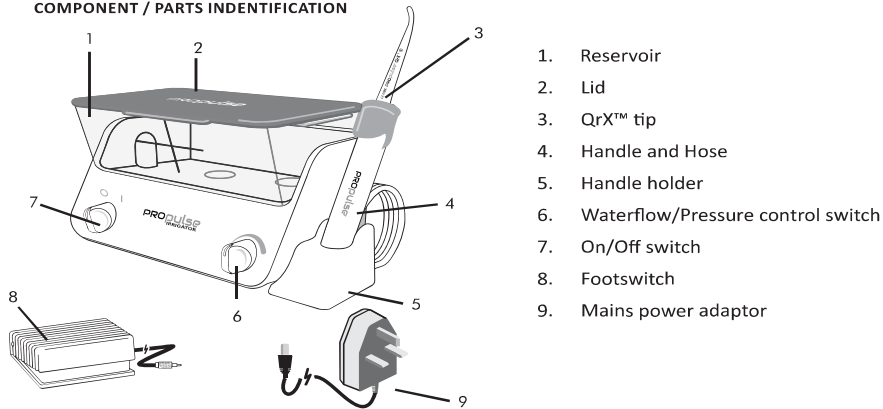

The Propulse® Ear Irrigator consists of:

- The main unit and the following user controls:
 - An On/Off switch
 - A footswitch which (when pressed) starts the flow of water. The water stops when the footswitch is released.
 - A mains power adaptor
- Water container/reservoir (1) is removable to facilitate filling and cleaning. Horizontal line indicates the correct level of water required for normal use, as well as the correct level of water required to dissolve cleaning tablet.
- Mushroom Valve – to retain the water in the reservoir when it is removed from the Propulse® machine.
- Handle and non-detachable hose. The Handle accommodates the Propulse® QrX™ Single Use Tips.
- The footswitch - is connected to the main body via a jack plug/socket connection. The device will only function if the footswitch is connected.













Please note: Residual water in the handle and hose will continue to flow if the handle is not held in the vertical position or, if the handle is held in a position that is lower than the machine. To prevent residual flow, it is recommended that the handle be returned to its holder on the machine.

TECHNICAL DATA

Performance:

Flow rate:	Up to 300ml/minute
Water jet pulses:	1200 per minute (approximately)
Maximum operating time:	10 minutes continuous use (with a recommended rest time of 2 hours)
Storage temperature range:	-5°C to 65°C
Storage relative humidity:	up to 80%
Power adaptor:	Input 100-240v ~ 50/60Hz Max 0.45A Output 9v DC2A
Electrical Safety:	EN6061-1
EMC Compliance:	EN60601-1-2

GUIDE TO SYMBOLS

	Attention - Consult Accompanying Documents
	Type BF Electrical safety
IPX1	Protected against water droplets
	Single use item
	Conforms to the Medical Device Directive 93/42/EEC
	Must be disposed of in accordance with European waste electrical and electronic equipment directive 2002/96/EC
	Manufactured by
	Power On
	Power Off
9v 	DC Current
	Variable Flow Rate
10min/2hr	Duty Cycle
	Read Instruction Manual
	Indoor use only

OPERATING INSTRUCTIONS

These instructions are for general use. When required, refer to the detailed information in the second half of this manual.

- Ensure that **ONLY** suitably trained clinicians operate the device.
- Ensure that the warnings and cautions are observed.
- Ensure that the patient exhibits no contraindications (refer to page 12).
- Ensure the unit has been cleaned **prior to first use**, and every day prior to use (refer to page 10 for detailed cleaning guidance).
- The device may only be operated whilst connected to the mains electrical supply using the Power Adaptor and footswitch provided.
- The reservoir should be removed prior to filling.
- The water reservoir must be filled to the horizontal line on the front of the reservoir.
- Monitor temperature regularly to ensure that patient comfort and safety is maintained. Refill as necessary.
- Fit a new Propulse® QrX™ Single Use Tip to the Handle.
- Adjust the Waterflow Switch (6) to an appropriate level.
- Turn the On/Off Switch (7) to the position marked "I".
- Adjust the waterflow to an appropriate value that is compatible with the treatment requirements and patient comfort.
- Direct the irrigator tip into the noots tank and switch on the machine for 10-20 seconds in order to circulate the water through the system and eliminate any trapped air or cold water.
- Ensure the water is warm before presentation to the patient.
- During treatment you can pause the flow by releasing the footswitch.
- After treatment empty the reservoir and operate the device to purge any residual water.
- Remove the Propulse® QrX™ Tip and dispose of in accordance with local authority guidelines.
- Turn off the On/Off switch after use **and** disconnect from the power supply.
- Clean the Propulse® Ear Irrigator unit **every** morning **prior** to use, with a Propulse cleaning tablet (See page 10).
- The Propulse® Ear Irrigator should only be transported in a Propulse® approved carry case to prevent damage or contamination.
- If any changes in performance occur, turn off the Propulse® Ear Irrigator, disconnect from the mains electricity supply and **DO NOT** use. Please refer the machine to Mirage.

DETAILED INFORMATION

Fitting the Footswitch

The Propulse® footswitch is connected to the main unit by a socket in the side of the device. The Propulse® Ear Irrigator will NOT operate unless the footswitch is connected.

Filling the water reservoir

It is recommended that:

- i) The water reservoir is removed from the device for filling and that the lid is always in place when the water container is in-situ on the device.
- ii) The water reservoir should be filled to the horizontal line on the front. This helps to eliminate the risk of spillage.
- iii) Water at 40°C is recommended. Higher temperatures increase the risk of scalding and burns to the patient. Lower temperatures increase the risk of patient discomfort and dizziness.

Fitting the Propulse® QrX™ Tip

The Propulse® Ear Irrigator is designed to be used only with Propulse® QrX™ Single Use Tips. Use one Propulse® QrX™ Tip per treatment.

To fit a Propulse® QrX™ Tip

- 1) Remove Tip from packaging - Tips are non-sterile.
- 2) Push Tip into Handle until a click can be heard.

To remove a Propulse® QrX™ Tip

- 1) Retract the QrX™ Locking Collar using a thumb.
- 2) Grasp the used QrX™ Tip between forefinger and thumb and pull gently from the QrX™ Handle.
- 3) Dispose of the used Tip in accordance with local authority guidelines. DO NOT REUSE TIPS.

Propulse® QrX™ Tips are available to purchase in boxes of 100 individually wrapped (non-sterile) tips from your normal Propulse® supplier or from Mirage directly (UK only). Propulse® QrX™ Tips are clearly branded with the Propulse® logo on the tip and its packaging. Only branded Propulse® QrX™ Tips should be used with the Propulse® Ear Irrigator.

Replacing the Mushroom Valve

The Mushroom Valve is specifically designed to prevent water flowing out of the reservoir whilst filling. Should a replacement Mushroom Valve be required, please follow the steps below -

Firstly, ensure you are fitting the correct mushroom valve for this model Propulse® Ear Irrigator.

This will help prevent possible damage to the water inlet valve.

- 1) Remove the reservoir from the Propulse® Ear Irrigator.
- 2) Remove the old Mushroom Valve from the reservoir and discard
- 3) Insert a new Mushroom Valve without bending or exerting undue force on the legs of the Mushroom Valve, into the reservoir.
- 4) Check the condition of the 'O' ring on the base of the reservoir and if worn replace with a new unit specific 'O' ring.
- 5) Return the reservoir to the machine

Guidance and Manufacturer's Declaration – Electromagnetic emissions			
The Propulse is intended for use in the electromagnetic environment specified below. The customer or user of the Propulse should assure that it is used in such an environment.			
Emission tests	Compliance	Electromagnetic environment – guidance	
RF emissions CISPR 11	Group 1	The Propulse uses only energy for its internal function. Therefore, its RF emissions are not likely to cause any interference in nearby electronic equipment.	
RF emissions CISPR 11	Class A	The Propulse is suitable for use in all establishments other than domestic and those directly connected to the public low-voltage power supply network that supplies buildings used for domestic purposes.	
Harmonic emissions IEC 61000-3-2	Class A		
Voltage fluctuation/flicker emissions IEC 61000-3-3	Complies		
Guidance and Manufacturer's Declaration – Electromagnetic Immunity			
The Propulse is intended for use in the electromagnetic environment specified below. The customer or the user of the Propulse should assure that it is used in such an environment			
Immunity test	IEC 60601 test level	Compliance level	Electromagnetic environment - guidance
Electrostatic discharge (ESD) IEC 61000-4-2	6 kV contact 8 kV air	6 kV contact 8 kV air	Floors should be wood, concrete or ceramic tile. If floors are covered with synthetic material, the relative humidity should be at least 30%.
Electrical fast transient/ burst IEC 61000-4-4	2 kV for power supply lines 1 kV for input/output lines	2 kV for power supply lines Not applicable	Mains power quality should be that of a typical commercial or hospital environment.
Surge IEC 61000-4-5	1 kV differential mode 2 kV common mode	1 kV differential mode 2 kV common mode	Mains power quality should be that of a typical commercial or hospital environment.
Voltage dips, short interruptions and voltage variations on power supply input lines IEC 61000-4-11	< 5 % UT (> 95 % dip in UT) for 0.5 cycle 40 % UT (60 % dip in UT) for 5 cycles 70 % UT (30 % dip in UT) for 25 cycles < 5 % UT (> 95 % dip in UT) for 5 s	< 5 % UT (> 95 % dip in UT) for 0.5 cycle 40 % UT (60 % dip in UT) for 5 cycles 70 % UT (30 % dip in UT) for 25 cycles < 5 % UT (> 95 % dip in UT) for 5 s	Mains power quality should be that of a typical commercial or hospital environment. If the user of the Propulse requires continued operation during power mains interruptions, it is recommended that the Propulse be powered from an uninterruptible power supply or a battery.
Power frequency (50/60 Hz) magnetic field IEC 61000-4-8	3 A/m	Not applicable	Power frequency magnetic fields should be at levels characteristic of a typical location in a typical commercial or hospital environment.
NOTE UT is the A.C. mains voltage prior to application of the test level.			

Guidance and Manufacturer's Declaration - Electromagnetic Immunity			
The Propulse is intended for the use in the electromagnetic environment specified below. The customer or the user of the Propulse should assure that it is used in such an environment			
Immunity test	IEC 60601 test level	Compliance level	Electromagnetic environment – guidance
Conducted RF IEC 61000-4-6 Radiated RF IEC 61000-4-3	3 Vrms 150 kHz to 80 MHz 3 V/m 80 MHz to 2,5 GHz	3 Vrms 3 V/m	Portable and mobile RF communications equipment should be used no closer to any part of the Propulse, including cables, than the recommended separation distance calculated from the equation applicable to the frequency of the transmitter: Recommended protection distance: d = 1.17 vP d = 1.17 vP for 80 MHz to 800 MHz d = 2,3 vP for 800 MHz to 2.5 GHz where P is the maximum output power rating of the transmitter in watts (W) acc. To the transmitter manufacturer and d is the recommended separation distance in meters (m). Field strengths from fixed RF transmitters, as determined by an electromagnetic site survey, should be less than the compliance level in each frequency range. ⁹ Interference may occur in the vicinity of equipment marked with the following symbol: 
NOTE 1: At 80 MHz and 800 MHz, the higher frequency range applies. NOTE 2: These guidelines may not apply in all situations. Electromagnetic propagation is affected by absorption and reflections from structures, objects and people.			
a. Field strengths from fixed transmitters, such as base stations for radio (cellular/cordless) telephones and land mobile radios, amateur radio, AM and FM radio broadcast and TV broadcast cannot be predicted theoretically with accuracy. To assess the electromagnetic environment due to fixed RF transmitters, an electromagnetic site survey should be considered. If the measured field strength in the location in which the Propulse is used exceeds the applicable RF compliance level above, the Propulse should be observed to verify normal operation. If abnormal performance is observed, additional measures may be necessary, such as reorienting or relocating the Propulse. b. Over the frequency range 150 kHz to 80 MHz, field strengths should be less than 3 V/m.			

Recommended Separation Distance between portable and mobile RF Communications Equipment and the Propulse			
The Propulse is intended for use in an electromagnetic environment in which radiated RF disturbances are controlled. The customer or the user of the Propulse can help prevent electromagnetic interference by maintaining minimum distance between portable and mobile RF communications equipment (transmitters) and the Propulse as recommended below, according to the maximum output power of the communications equipment.			
Rated maximum output power of transmitter (W)	Separation distance according to the transmit frequency (m)		
	150 kHz to 80 MHz d = 1.17 v P	80 MHz to 800 MHz d = 1.17 v P	800 MHz to 2,5 GHz d = 2.33 v P
0.01	0.12	0.12	0.23
0.1	0.38	0.38	0.73
1	1.2	1.2	2.3
10	3.8	3.8	7.3
100	12	12	23.
For transmitters rated at a maximum output power not listed above, the recommended separation distance d in meters (m) can be estimated using the equation applicable to the frequency of the transmitter, where p is the maximum output power rating of the transmitter in watt (W) according to the transmitter manufacturer.			
NOTE 1 At 80 MHz and 800 MHz, the separation distance for the higher frequency range applies. NOTE 2 These guidelines may not apply in all situations. Electromagnetic propagation is affected by absorption and reflection from structures, objects and people.			

Cleaning Instructions

The importance of using the correct strength cleaning solution cannot be overstated. A solution that is too strong will in time damage the Propulse® Ear Irrigator. A solution that is too weak will fail to provide the correct level of cleaning and decontamination. Mirage Health Group recommends the use of Propulse® CHLOR-CLEAN® Tablets. They are easy and effective to use and provide a measured / specific strength of cleaning solution that is safe and kind to the Propulse® internal components.

Ensure the unit has been cleaned prior to first use.

1. Place warm tap water into the reservoir up to the horizontal line on the front.
2. Place one Propulse® CHLOR-CLEAN® tablet into the reservoir and allow it to dissolve completely.
3. Once dissolved run the machine until the cleaning solution leaves the handle. This ensures that the cleaning solution has reached all of the internal components.
4. Leave the solution in place for 10 minutes.
5. After 10 minutes remove the reservoir with the remaining cleaning solution and discard.
6. Fill the reservoir with clean, well run, cold tap water and return to the Propulse®.
7. Run the Propulse® ensuring that all remaining cleaning solution has been flushed through.
8. Remove reservoir, discard water and dry reservoir thoroughly with a paper towel.
9. Return reservoir to the Propulse® - it is now ready for use.

Cleaning

Do not attempt to clean the Propulse® QrX™ Tip. Use one Propulse® QrX™ Tip per patient treatment and discard to clinical waste after use as this reduces the risk of cross infection between patients.

External cleaning of the Propulse® Ear Irrigator should be done by hand, wiping with a damp cloth only. Apply liquids to the cloth not the unit. Do not immerse the unit in water. Mild detergents and disinfectants may be used externally.

Power Adaptor

Connect the outlet lead of the Power Adaptor to the Power Adaptor socket marked on the end of the product and to the mains electrical supply. Make sure the cord and Power Adaptor are positioned so that they will not be subjected to damage or stress or present a trip hazard.

Only use a Propulse® branded Power Adaptor.

To reduce the risk of electric shock, unplug the unit from the power source before attempting to clean it externally.

The Power Adaptor must not be used outdoors or in damp areas.

The Propulse® Power Adaptor will have been supplied with an appropriate plug for your region OR a selection of international plugs. Please fit the appropriate plug for your region. If there are any problems connecting to the mains electrical supply consult a qualified electrician.

Contraindication to irrigation

Rationale

If the patient has experienced any complications from a previous episode of irrigation with water.

If the patient did not tolerate a previous episode of irrigation it would be unwise to repeat the procedure in case the symptoms are exacerbated.

There has been evidence of a middle ear infection (Otitis Media) in the last 2 months.

The tympanic membrane may be vulnerable to damage due to the adverse effect infected fluid may have on the ear drum.

The patient has undergone any form of ear surgery apart from grommets, which are documented to be extruded from the tympanic membrane for over 2 years and the patient is discharged from the ENT department.

There will be a weakness to the structure of the ear canal and tympanic membrane after surgery. This does not include cosmetic surgery to the pinna (for example repair of bat ears). If the tympanic membrane is intact 2 years post grommet extrusion, there should not be an increased risk of damage to the tympanic membrane.

There is a suspected or actual perforation present or there is a history of mucous discharge from the ear in the last 2 years.

A mucous discharge would indicate a perforation and water entry under pressure could cause infection or damage the delicate middle ear structures.

If the patient has a cleft palate (regardless of whether it has been repaired or not).

A cleft palate indicates an underdeveloped facial skeleton and as such the tympanic membrane and middle ear structures could be more vulnerable to damage.

In the presence of acute otitis externa (pain, swollen ear canal and tenderness of the pinna).

Although it is essential to thoroughly clean the infected ear canal, when it is swollen debris should be removed by microsuction.

Profound hearing loss in one ear.

There is a risk associated with any intervention and when a patient completely relies on one ear for hearing (as the other ear has a profound hearing loss) any risk to this ear is unacceptable.

Caution when irrigating with water in the following groups of patients

Rationale

Patient is taking anti-coagulants.

The lining of the ear canal is delicate and there is a higher risk of bleeding so ensure trauma to the ear canal is avoided.

The patient is diabetic.

The pH of wax in patients who are diabetic is a higher pH than average, increasing their vulnerability to infection.

Tinnitus.

Although wax impaction can cause tinnitus, trauma to the tympanic membrane may exacerbate this.

Vertigo.

This is also a symptom of wax impaction but irrigation can trigger an episode so ensure appropriate water temperature and patient safety.

Radiotherapy that has involved the ear canal.

A radiated ear canal can develop bony necrosis so wax should be removed before it becomes hard and trauma to the canal should be avoided.

Maintenance & Safety Inspections

To ensure optimum performance the Propulse® Ear Irrigator should be serviced every 12 months. Service or repairs conducted by unauthorised agencies/organisations invalidate any or implied warranties from Mirage.

The Propulse® Ear Irrigator should under-go routine electrical safety testing to ensure that it remains safe to use, in accordance with EN ISO 62353:2014

Users of the Propulse® Ear Irrigator should carry out regular inspections to ensure that the handle and hose, power adaptor and cable, reservoir, footswitch and main body of the machine are free from damage prior to use. If any damage is evident, the Propulse® Ear Irrigator should NOT be used until replacement parts have been fitted.

Only Propulse® branded items should be used with the Propulse® Ear Irrigator.

The Propulse® Ear Irrigator is not user repairable and should be returned to your Propulse® supplier or Mirage Health Group (UK customers only) for service and/or repair:



Mirage Health Group Service Centre

11 Tewin Court,
Welwyn Garden City,
Hertfordshire AL7 1AU

UKTel - +44 (0) 845 130 5445

The clinical procedures relating to the use of ear irrigators can be found on the following websites:

www.earcarecentre.com

www.entnursing.com/earcare.htm

Mirage is not responsible for the content or maintenance of third party internet sites.

Mirage can also advise on the availability of training courses offered by the relevant organisations.

Additional information on use of the Propulse® can be found at:

<http://www.youtube.com/user/MirageHealthGroup>

Warranty

The Propulse® Ear Irrigator carries a twelve month warranty (*subject to conditions) from the date of original purchase. Should any defect arise due to faulty material or workmanship, Mirage Health Group will, upon receipt of the faulty Propulse® Ear Irrigator, proof of purchase, information relating to the nature of the fault and details of where the item was purchased, rectify the fault at no cost to you.

Should any of the “Accessory” items (listed below) prove to be faulty as a result of defective material or workmanship, Mirage Health Group will rectify the issue free of charge upon receipt of the faulty accessory (*subject to conditions).

“Accessory” items are: Footswitch; Reservoir / Tank and Lid; Mushroom Valve and Washer; QrX™ Tip; Power Supply Lead and Power Transformer.

*Conditions of Warranty (applicable to Propulse® Electronic Ear Irrigator and “Accessory” items).

The warranty does not cover:

- Accidental damage or damage caused by misuse.
- Faults caused due to lack of maintenance.
- Damage caused by using the Propulse® Ear Irrigator for any use other than its intended use.
- Damage caused as a result of repair by any unauthorised agents - ONLY Mirage Health Group should undertake repairs.
- Damage caused by the use of accessories / cleaning products that have not been recommended by Mirage Health Group as suitable for your model irrigator.

This warranty is in addition to, and does not diminish your statutory or legal rights.

Additional user manuals and other accessories are available from Mirage Health Group Ltd at:



Mirage Health Group
11 Tewin Court,
Welwyn Garden City,
Hertfordshire AL7 1AU
UK

Tel - +44 (0) 845 130 5440

Fax - +44 (0) 845 130 6440

www.miragehealthgroup.com

uksales@miragehealthgroup.com

internationalsales@miragehealthgroup.com



Environmental Protection

This symbol on the products and/or accompanying documents means that used electrical and electronic products should not be mixed with general waste. Please return to Mirage Health Group or dispose of through locally approved disposal service for electronic equipment. Penalties may be applicable for incorrect disposal of this waste, in accordance with national legislation.

Disposing of used Propulse® QrX™ Tips

Disposal should be in accordance with local authority guidelines and regulations for the disposal of clinical waste. Propulse® QrX™ Tips should not be disposed of in municipal waste.

Transportation

Before the Propulse® Ear Irrigator is transported, the reservoir must be emptied and the machine should be operated until the handle and hose are empty of liquid. The reservoir should then be dried using a paper towel.

For safe transportation of Propulse® Ear Irrigator, Mirage recommends that the Propulse® Carry Case is used to prevent damage or contamination.
For internal cleaning, please refer to page 10.